

RoHS Compliant

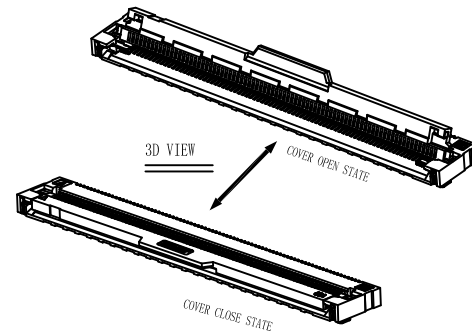
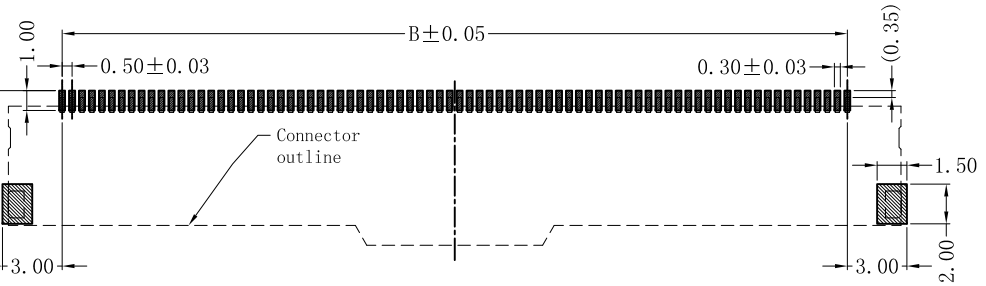
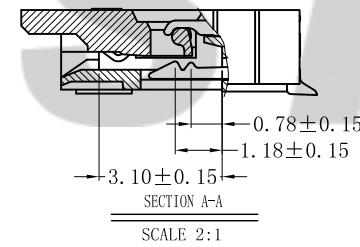
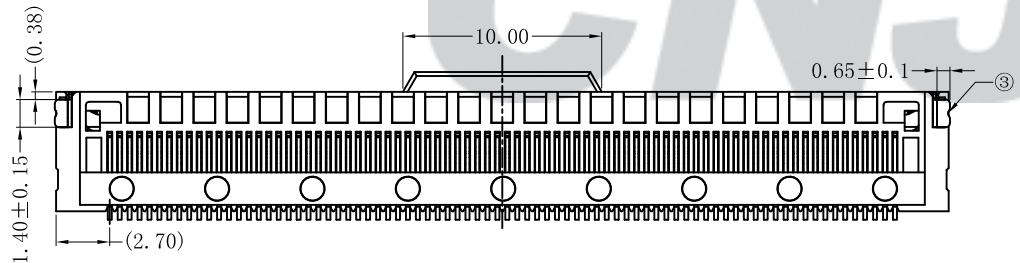
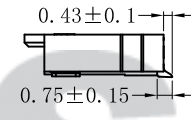
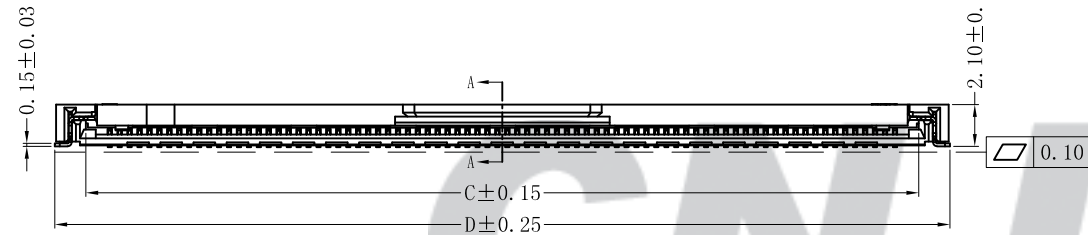
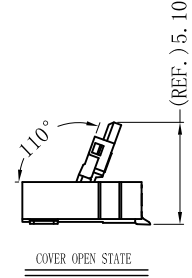
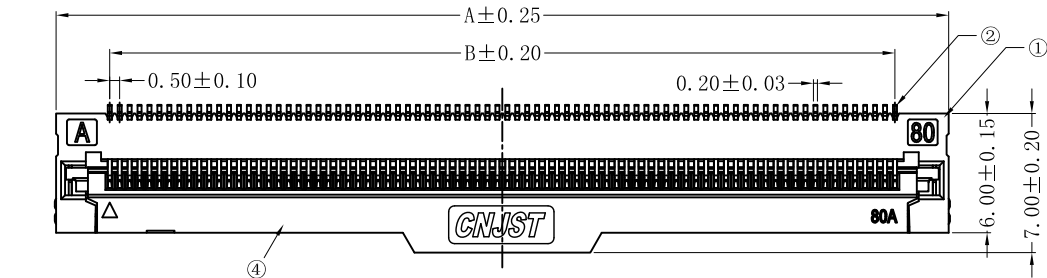

SPECIFICATION

- Contact resistance: $\leq 30m\Omega$
- Insulation resistance: $\geq 100M\Omega$
- Rated voltage: 50 V AC DC
- Rated current: 0.5A AC DC
- Withstand Voltage: 500V AC/minute
- Temperature Range: $-25^{\circ}C \sim +85^{\circ}C$

ORDER INFORMATION:

F0520AWR--F2ME-R**

PART No.:	PACKAGING:
No. OF CIRCUITS:	R=REEL
30~96	
PLASTIC MATERIAL:	PLATING:
F2M=LCP (Locker:LCP)	E=Contacts:Gold
	Solder tab:Tin

NO. of contacts	Dimensions			
	A	B	C	D
30	19.90	14.50	16.90	20.20
50	29.90	24.50	26.90	30.20
51	30.40	25.00	27.40	30.70
60	34.90	29.50	31.90	35.20
68	38.90	33.50	35.90	39.20
80	44.90	39.50	41.90	45.20
96	52.90	47.50	49.90	53.20

专利产品

REV.	DATE	DESCRIPTION	APPD.	NO.	DESCRIPTION	QTY	MATERIAL	PLATING/COLOR
C/0	2022.10.28	更新模板	李浩然	④	Locker	1	LCP (UL94V-0)	Black
B/0	2018.08.21	NEW RELEASE		③	Solder Tab	1	Phosphor Bronze	Matte Sn
				②	Contacts	30~96	Phosphor Bronze	Gold
				①	Insulator	1	LCP (UL94V-0)	Nature (Beige)

Tolerance	X.X ± 0.30
	X.XX ± 0.20
	X.XXX ± 0.10
	Angle ± 3.0°
UNIT:	mm

CNJST 捷仕泰企业

Model No.: F0520AWR-**-F2ME-R

Model Name: 0.50mm pitch SMT FFC/FPC CONNECTORS

SCALE: FULL

REVISION: C/0

Drawn: 李浩然 2022.10.28
Checked: 吴丹平
Approved: 林旭芝
DWG NO.: CNJST/GCCP-0622

RoHS Compliant

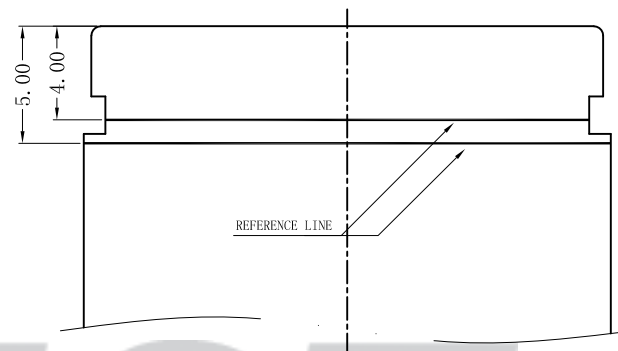
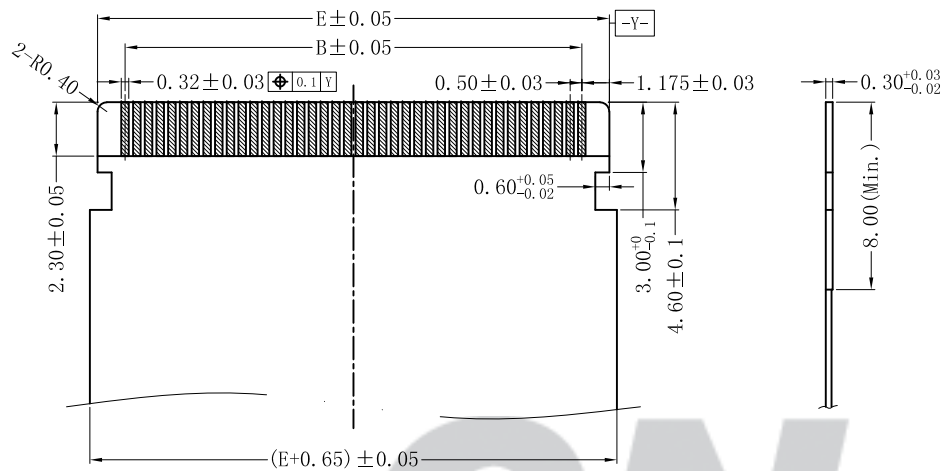

APPLICABLE FPC/FFC 1

蓝白裸线 (不接地)

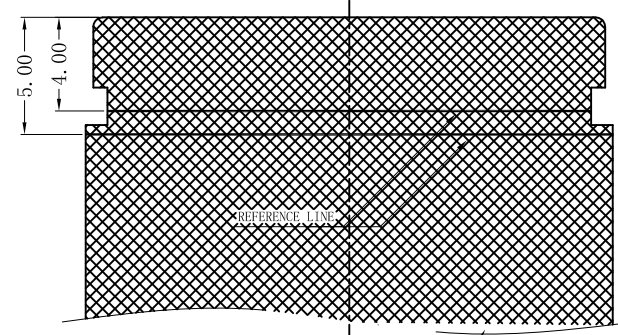
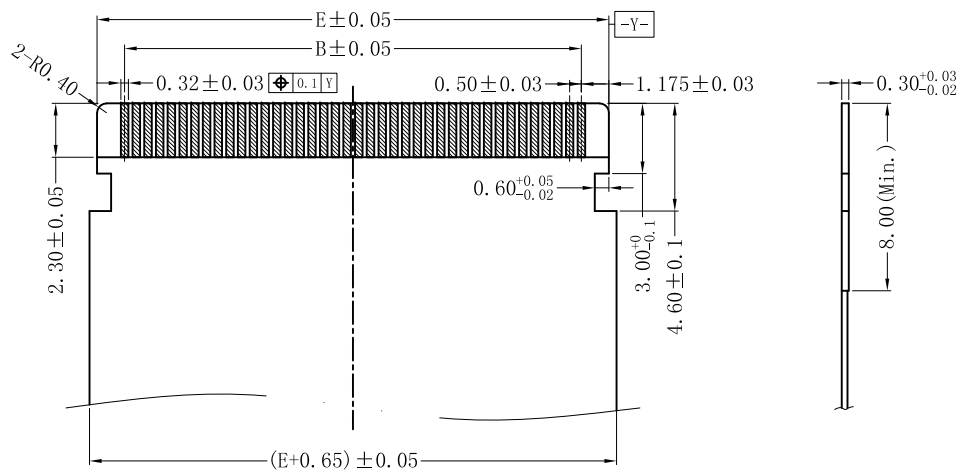

一体补强板铝箔FFC线

APPLICABLE FPC/FFC 2

一体补强板铝箔FFC线

NO. of contacts	Dimensions	
	B.	E.
30	14.50	16.85
50	24.50	26.85
51	25.00	27.35
60	29.50	31.85
68	33.50	35.85
80	39.50	41.85
96	47.50	49.85

Tolerance X.X ±0.30 X.XX ±0.20 X.XXX ±0.10 Angle ±3.0°	CNJST 捷仕泰企业		Drawn: 李浩然 2022.10.28
	Model No.: F0520AWR-**-F2ME-R		Checked: 吴丹平
UNIT: mm	Model Name: 0.50mm pitch SMT FFC/FPC CONNECTORS		Approved: 林旭芝
	SCALE: FULL		REVISION: C/0
			DWG NO.: CNJST/GCCP-0622

C/O	2022.10.28	更新模板	李浩然
B/O	2020.08.24	NEW RELEASE	
REV.	DATE	DESCRIPTION	APPD.