

RoHS Compliant

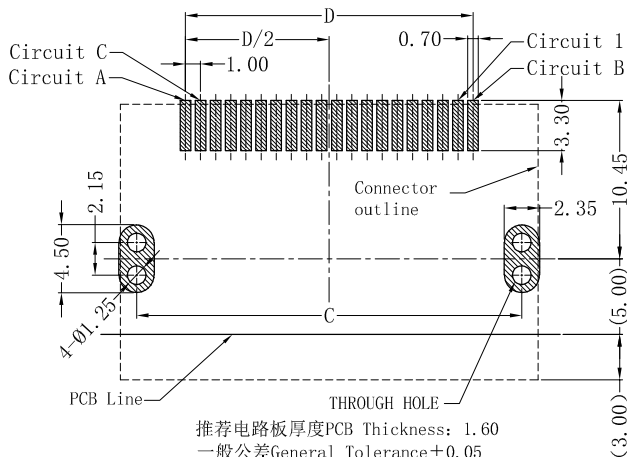

推荐电路板厚度PCB Thickness: 1.60
一般公差General Tolerance ±0.05

SUGGESTED PCB LAYOUT
(COMPONENT SIDE)

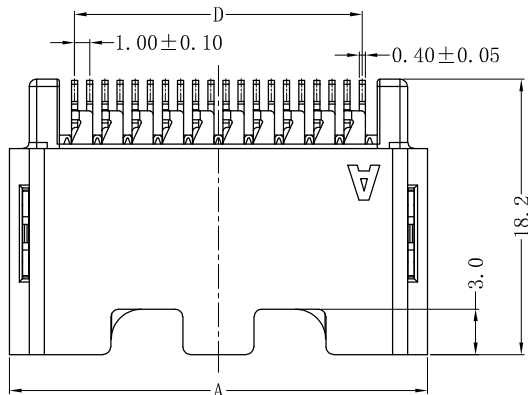
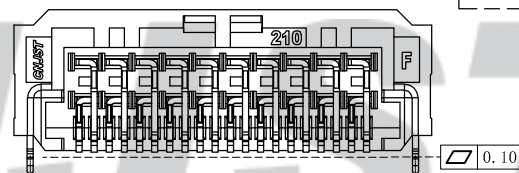
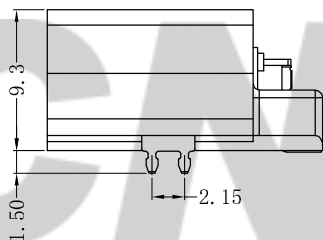
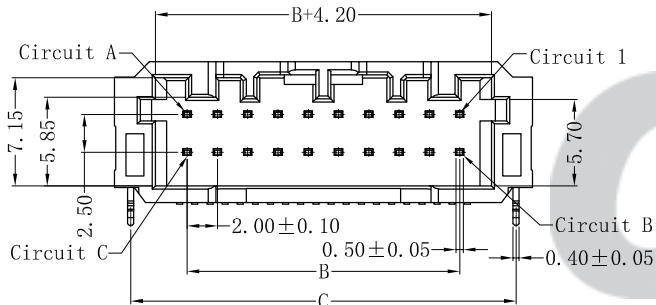

产品: A版本

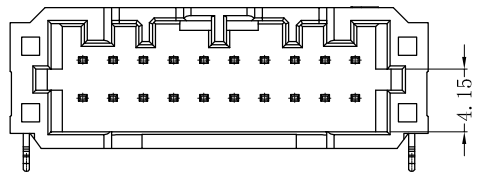
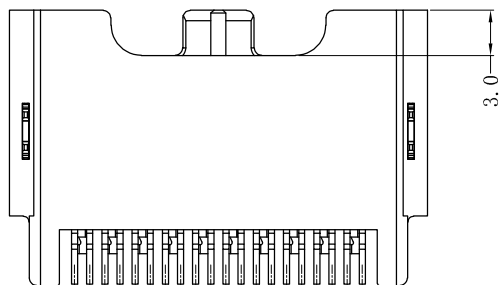

产品: B版本

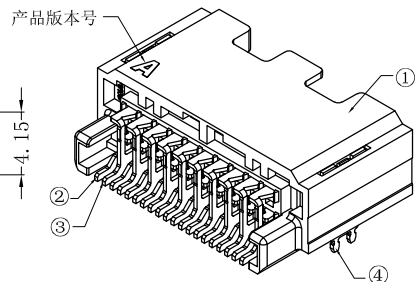

SPECIFICATION

- 1 Contact resistance: $\leq 25m\Omega$
- 2 Insulation resistance: $\geq 100M\Omega$
- 3 Rated voltage: 50 V AC DC
- 4 Rated current: 3.0 A AC DC
- 5 Withstand Voltage: 500V AC/minute
- 6 Temperature Range: $-40^{\circ}C \sim +125^{\circ}C$

ORDER INFORMATION:

QA2007AWRB-***-F1KA-R-*

PART No.:	VERSIONS:
No. OF CIRCUITS:	A, B
2X4~2X20	PACKAGING:
PLASTIC MATERIAL:	R=Reel
F1K=LCP (Black)	PLATING:
	A=Tin-plated

Circuits	Dimensions (mm)			
	A	B	C	D
204 (2X4)	15.60	6.00	13.45	7.00
205 (2X5)	17.60	8.00	15.45	9.00
206 (2X6)	19.60	10.00	17.45	11.00
207 (2X7)	21.60	12.00	19.45	13.00
208 (2X8)	23.60	14.00	21.45	15.00
210 (2X10)	27.60	18.00	25.45	19.00
212 (2X12)	31.60	22.00	29.45	23.00
214 (2X14)	35.60	26.00	33.45	27.00
216 (2X16)	39.60	30.00	37.45	31.00
220 (2X20)	47.60	38.00	45.45	39.00

注: 建议客户优先选择我司公母端产品配套使用, 若在没有使用我司公母端配套产品情况下, 出现因产品不匹配的质量问题, 我司将不承担任何风险及责任。

专利产品

REV.	DATE	DESCRIPTION	APPD.	NO.	DESCRIPTION	QTY	MATERIAL	PLATING/COLOR
C/2	2023.09.28	定位片雾锡改为亮锡	黄羨程	④	Solder Tab	2	Brass	Tin-plated (C2)
C/1	2023.08.02	增加B版本信息	黄羨程	③	Contacts	2	4~20	Brass
C/0	2023.05.23	NEW RELEASE	黄羨程	②	Contacts	1	4~20	Brass
				①	Insulator	1	LCP (UL94V-0)	Black

Tolerance	CNJST 捷仕泰企业 Model No.: QA2007AWRB-***-F1KA-R- Model Name: 2.00mm Pitch 90° Double Row Wafer With Lock-SMT TYPE	Drawn: 黄羨程 2023.09.28	
X.X ±0.30		Checked: 吴丹平	
X.XX ±0.20		Approved: 林旭芝	
X.XXX ±0.10		DWG NO. CNJST/GCCP-0830	
Angle ±3.0°	UNIT: mm	SCALE: FULL	REVISION: C/2

RoHS Compliant

A版本PIN位结构示意图:

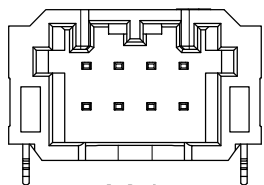

204

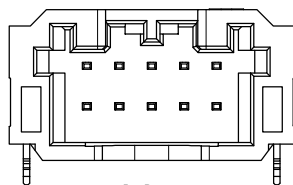

205

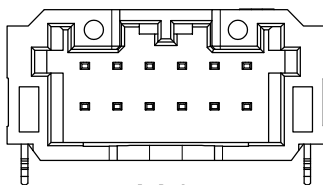

206

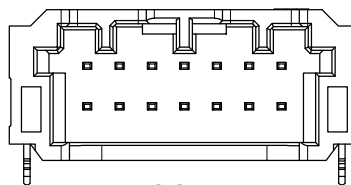

207

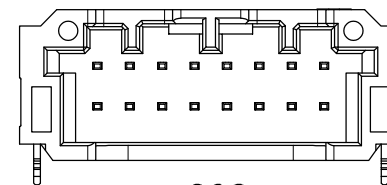

208

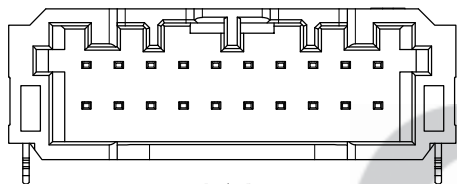

210

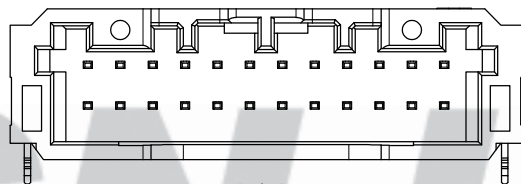

212

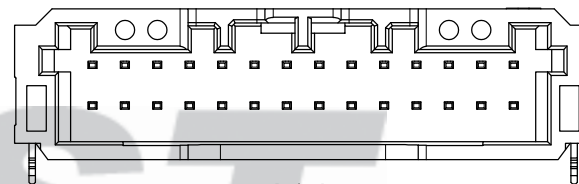

214

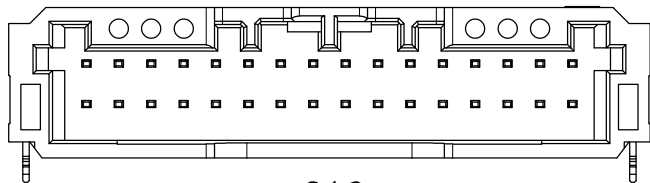

216

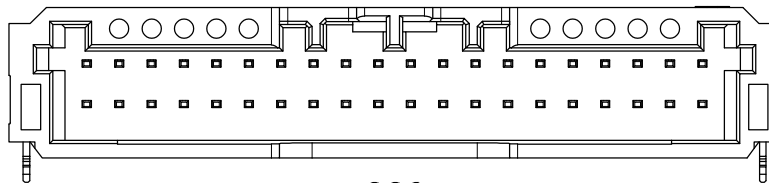

220

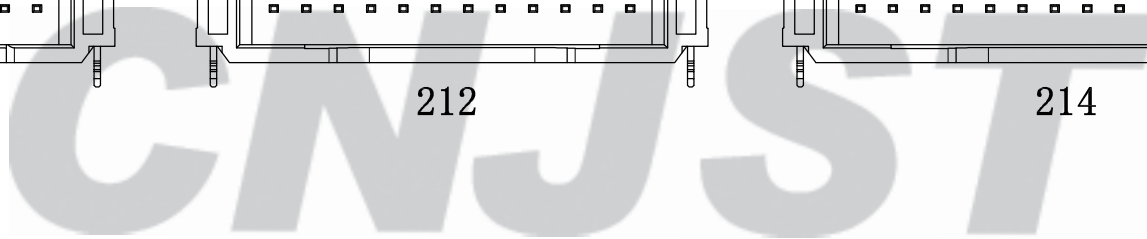

专利产品

REV.	DATE	DESCRIPTION	APPD.
C/2	2023. 09. 28	定位片雾锡改为亮锡	黄羨程
C/1	2023. 08. 02	增加B版本信息	黄羨程
C/0	2023. 05. 23	NEW RELEASE	黄羨程

注: 建议客户优先选择我司公母端产品配套使用, 若在没有使用我司公母端配套产品情况下, 出现因产品不匹配的质量问题, 我司将不承担任何风险及责任。

Tolerance X.X ±0.30 X.XX ±0.20 X.XXX ±0.10 Angle ±3.0°	CNJST 捷仕泰企业		Drawn: 黄羨程 2023. 09. 28
	Model No.: QA2007AWRB-***-F1KA-R-A		Checked: 吴丹平
UNIT: mm		SCALE: FULL	REVISION: C/2
			Approved: 林旭芝
			DWG NO. CNJST/GCCP-0830

RoHS Compliant

B版本PIN位结构示意图:

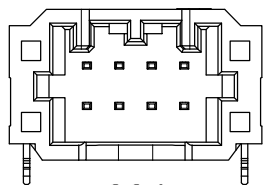

204

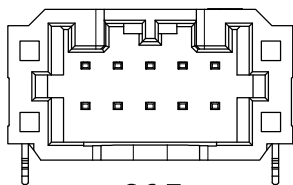

205

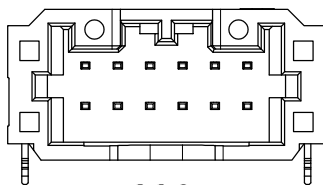

206

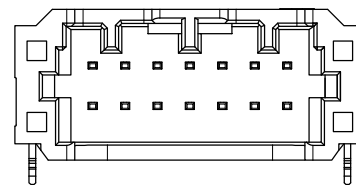

207

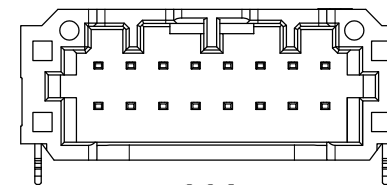

208

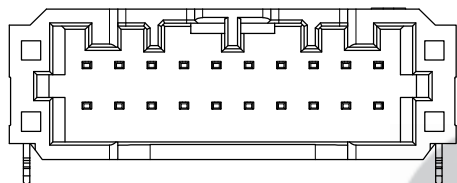

210

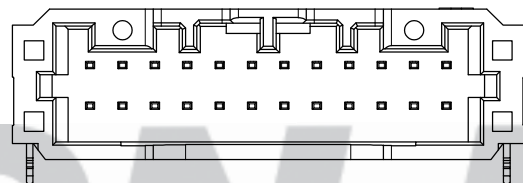

212

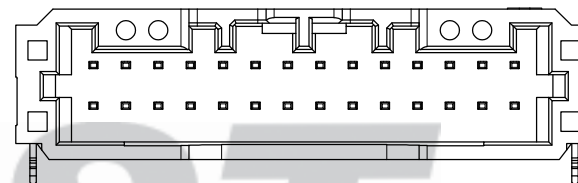

214

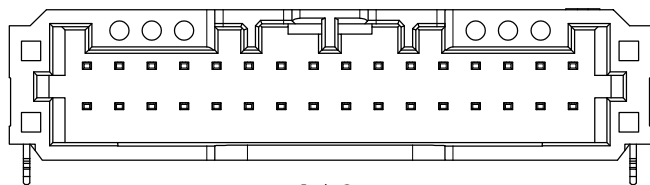

216

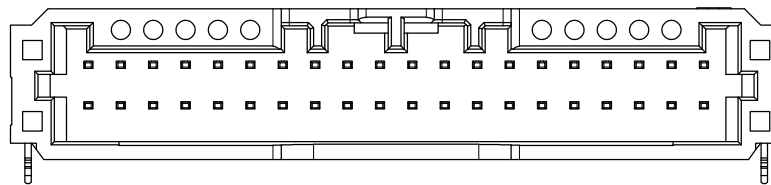

220

注: 建议客户优先选择我司公母端产品配套使用, 若在没有使用我司公母端配套产品情况下, 出现因产品不匹配的质量问题, 我司将不承担任何风险及责任。

专利产品

REV.	DATE	DESCRIPTION	APPD.
C/2	2023. 09. 28	定位片雾锡改为亮锡	黄羨程
C/1	2023. 08. 02	增加B版本信息	黄羨程
C/0	2023. 05. 23	NEW RELEASE	黄羨程

Tolerance X.X ±0.30 X.XX ±0.20 X.XXX ±0.10 Angle ±3.0°	CNJST 捷仕泰企业		Drawn: 黄羨程 2023. 09. 28
	Model No.: QA2007AWRB-***-F1KA-R-B		Checked: 吴丹平
UNIT: mm		SCALE: FULL	REVISION: C/2
			Approved: 林旭芝
			DWG NO. CNJST/GCCP-0830