

RoHS Compliant

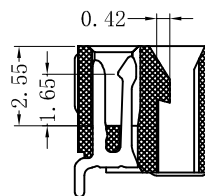

SECTION A-A

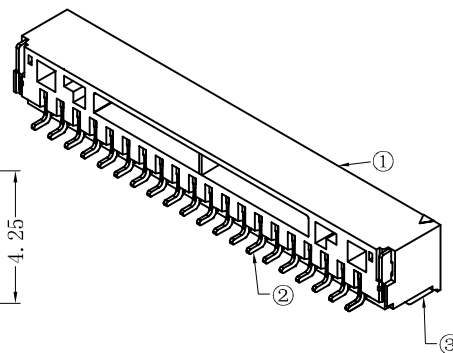
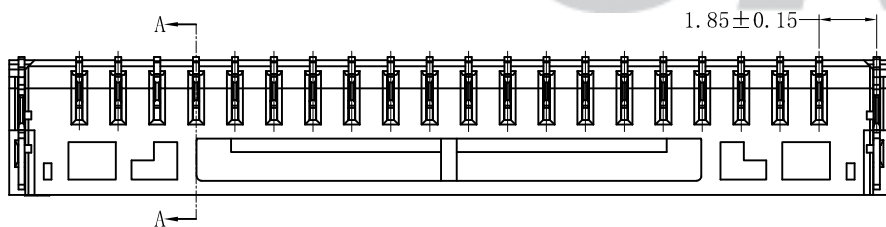
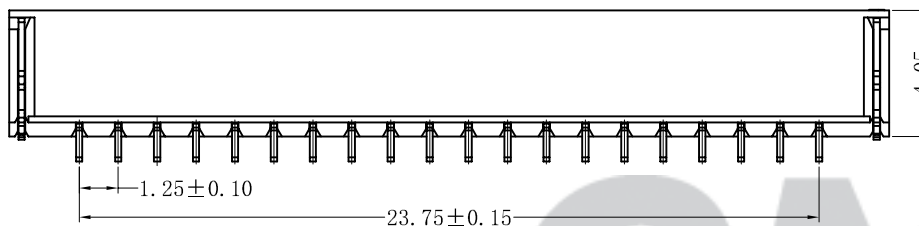
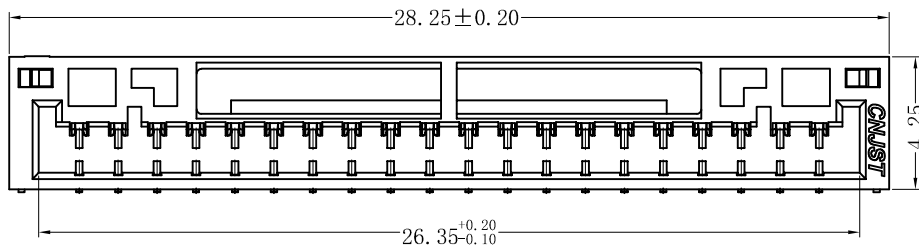
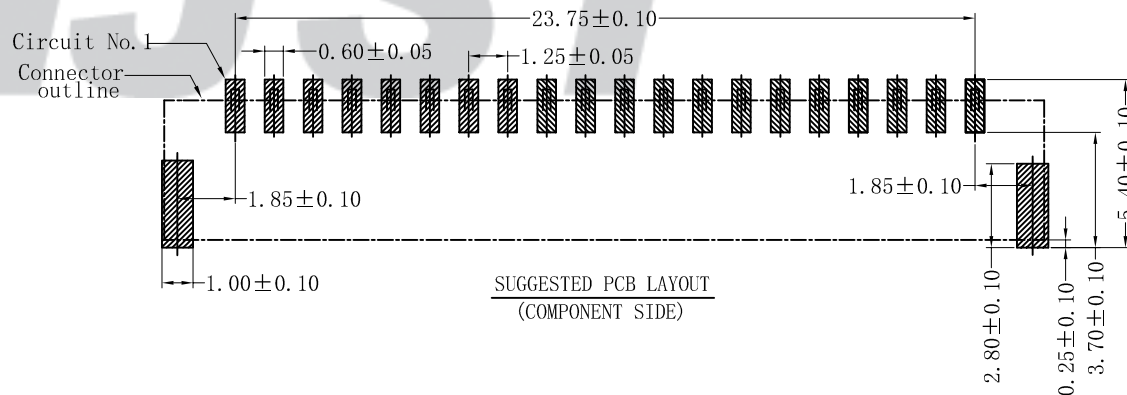

SPECIFICATION

- 1 Contact resistance:  $\leq 30m\Omega$
- 2 Insulation resistance:  $\geq 100M\Omega$
- 3 Rated voltage: 150 V AC DC
- 4 Rated current: 1.0 A AC DC
- 5 Withstand Voltage: 500V AC/minute
- 6 Temperature Range:  $-25^{\circ}C \sim +85^{\circ}C$

ORDER INFORMATION:

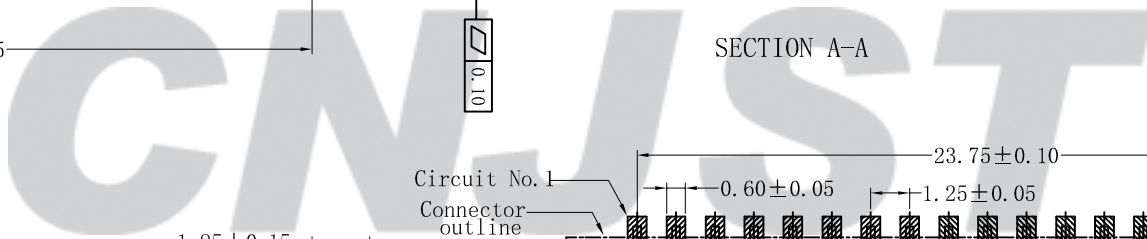
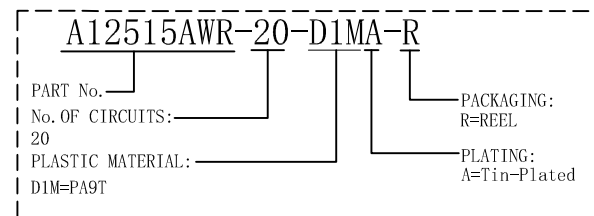

REV.	DATE	DESCRIPTION	APPD.	NO.	DESCRIPTION	QTY	MATERIAL	PLATING/COLOR
C/0	2022.12.07	统一标准 更新模版	黄羨程	③	Solder Tab	2	Phosphor Bronze	Tin-plated
B/0	2021.07.26	NEW RELEASE	王程伟	②	Material	20	Phosphor Bronze	Tin-plated
				①	Insulator	1	PA9T (UL94V-0)	Nature

Tolerance	X.X ±0.30
	X.XX ±0.20
	X.XXX ±0.10
Angle	±3.0°
UNIT:	mm

**CNJST 捷仕泰企业**

Model No.: A12515AWR-20-D1MA-R

Model Name: 1.25mm pitch 90° WAFER-SMT TYPE

SCALE: FULL

REVISION: C/0

Drawn: 黄羨程 2022.12.07
Checked: 吴丹平
Approved: 林旭芝
DWG NO.: CNJST/GCCP-0271