

RoHS Compliant

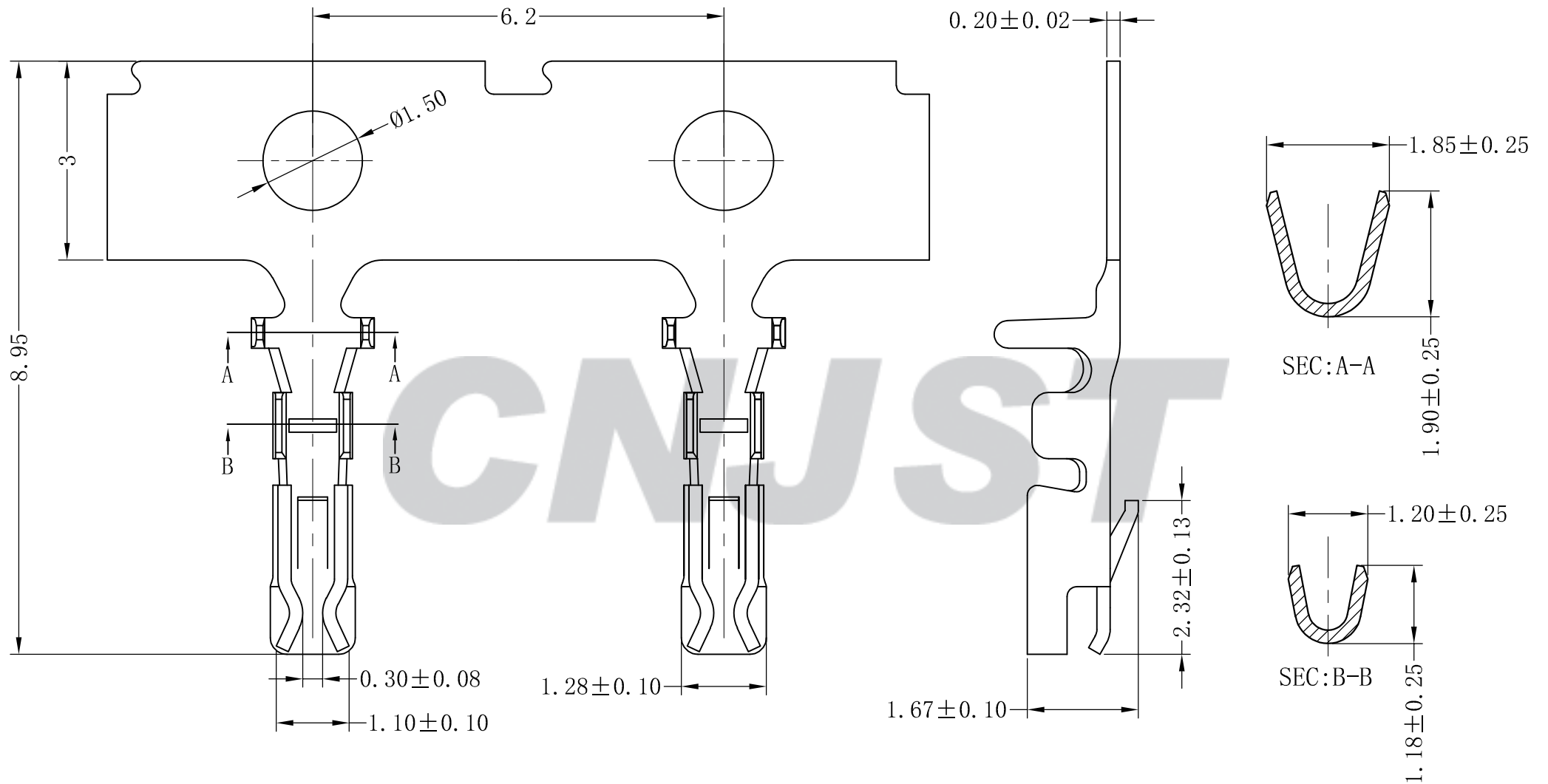

REV.	DATE	DESCRIPTION	APPD.	Wire Range	Insulation O.D.	QTY/Reel	Material	Plating
C/0	2022.07.12	更新模板	王程伟					
B/0	2020.08.22	NEW RELEASE		AWG #24~#32	1.1mm (Max)	13,000PCS	Phosphor Bronze	Tin-plated

Tolerance	X.X ±0.30
	X.XX ±0.20
	X.XXX ±0.10
	Angle ±3.0°

CNJST 捷仕泰企业

Model No. : A1802T-PA-Z

Model Name: 1.80mm PITCH CRIMP TERMINAL

UNIT: mm

SCALE: FULL REVISION: C/0

Drawn: 黄美程 2022.07.12
Checked: 吴丹平
Approved: 林旭芝
DWG NO. CNJST/GCDZ-0084